

Battery Capacity Tester

—Instruction—

• Sketch :

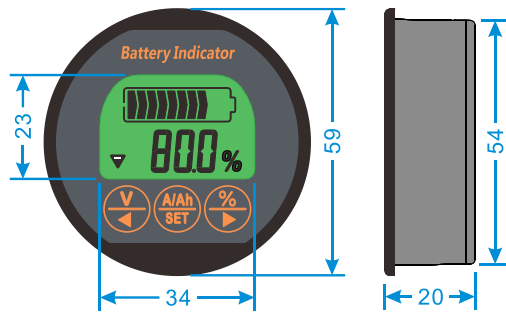

• Product overviews :

★ Tester is a kind of high precision current type battery capacity tester(also known as coulometer), which can test the voltage, current and capacity of battery to help users know the state of battery in time. Tester has memory function. It is suitable for mobile and portable equipments, e-bike, balance cars, cleaning machines, instruments, ups and so on.

• Application :

★ Tester is suitable for lithium batteries, lithium iron phosphate batteries, lead-acid batteries and nickel-metal hydride batteries which working voltage is from 8V to 120V.

• Basic parameters :

Parameter	Min	Type	Max	Unit
Working voltage	8.0		120.0	V
Working dissipation		10.0	12.0	mA
Standby dissipation		0.5	0.6	mA
Sleep dissipation		50	60	uA
Voltage accuracy		±1.0		%
Current accuracy		±1.0		%
Capacity accuracy		±1.0		%
Backlight on current(50A)	30.0		60.0	mA
Backlight on current(>50A)	80.0		120.0	mA
Preset capacity value	0.1		999	Ah
Current of 50A sampler	0.0	50.0	75.0	A
Current of 100A sampler	0.0	100.0	200.0	A
Current of 350A sampler	0.0	350.0	500.0	A

Temperature range	0	20	35	°C
Weight				g
Size	ø59*20			mm

• Working interface description :

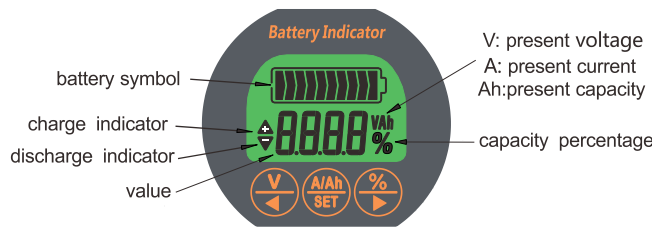

• Connect :

★ We need a shielded wire and an ordinary wire (0.3-0.75 mm²). One end of the ordinary wire connects to positive of battery, another end connects to B+ of sampler (any one is ok). The B- of sampler connects to B- of battery. P- of sampler connects to P- of output. Finally connect sampler to coulometer by the shielded wire. (Notice: The diagram is not equal proportion)

★ Connection diagram of 50A sampler :

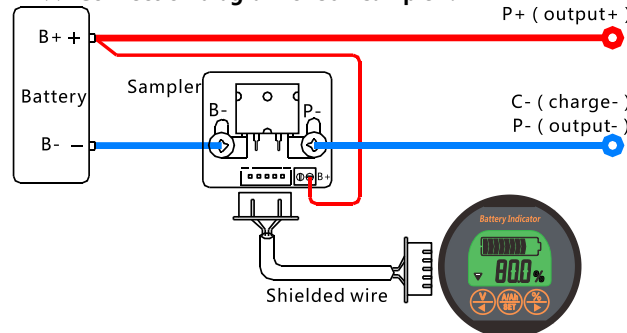

★ Connection diagram of 100A/350A sampler :

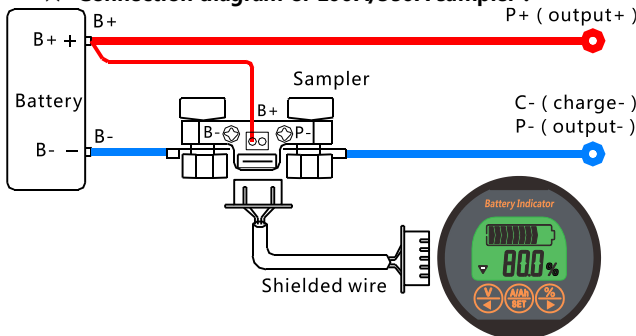

★ Connection diagram of 500A sampler :

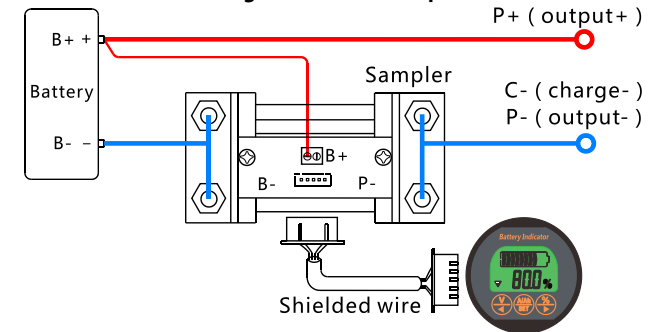

Attention: Please connect as shown strictly. The sampler must be connected to the negative circuit, it is forbidden to connect to the positive circuit. If you want to extend the shielded wire, you must use 4 lines of same specification.

• Install :

★ First, open a round hole of 54.5mm on the panel of the equipment. Then install the coulometer from the front of the panel. Finally, tighten the bracket on the back. As shown below:

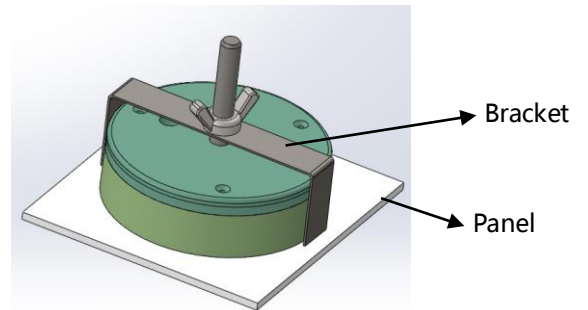

• Using steps :

1. Connect and check the current : Power on after complete the connection as shown, the screen should display capacity percentage. If the screen has no response, please check the connection. Then charge or discharge the battery, and **check whether the display current is equal to the actual current.** If the deviation is large please check the connection.

2. Capacity reset : On first use, the percentage and capacity are not the actual value, you should reset the capacity: discharge the battery totally and **hold the "V" key for 3 seconds to set the capacity zero** or charge the battery fully and **hold the "A/Ah" key for 3 seconds to set the capacity full.** And it doesn't need to do this again later, except replace the battery.

3. Check and reset the actual capacity :If you find the display capacity don't match the actual capacity , please check and reset the actual capacity : discharge the battery totally and hold the “” key for 3s to set the capacity zero , then set the capacity value as large as possible. Then charge the battery fully , and the display capacity is the actual capacity. Finally set the display capacity as preset capacity (Please refer to use and setting).

• Other description :

1. When charging or discharging , the coulometer must be at work. Otherwise the capacity will not be accurate.

2. Connect the load , when the discharge current is higher than backlight on current, the backlight on (if backlight blinking , the RS+ and RS- are inversely), and display discharge indicator ,indicate battery is discharging.



3. Break the load , and connect the charger. When the charge current is higher than backlight on current , backlight blinking (if backlight on , the RS+ and RS- are inversely), and display charge indicator ,indicate battery is charging.

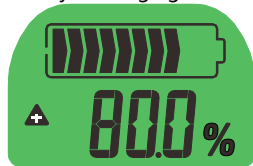





4. When the charge or discharge current is less than backlight off current, coulometer enter a low power state and backlight off. And Tester can memory the capacity.

5. Because of high sensitivity , when the coulometer is in standby mode (battery has no input or output current) , if it is interfered by electromagnetic radiation (open or close inductive loads , such as the motor) nearly , the backlight will shortly open.

6. When the current changes frequently the date acquisition may produce error , and it will affect the accuracy.





• Use and setting :

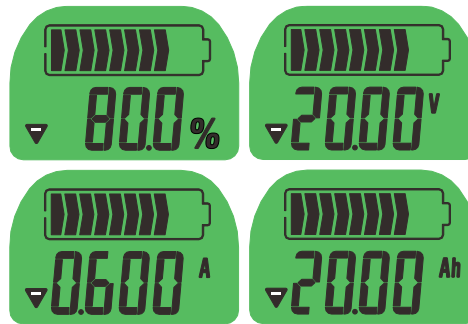



★ Change display interface :

After power on, display capacity percentage. Click “” key, display voltage; click “” key, display capacity, click “” key again, display current; click “” key, display percentage.





★ Preset capacity and voltage setting :

1. Under voltage display, press the “” key for 3s to enter zero capacity voltage setting. The set bit flicker, click the “” or “” key to plus and minus the value, then press the “” key to complete setting. When the voltage is lower than the value the percentage will be 0% , and backlight off.

2. Under capacity display, press the “” key for 3s to enter capacity setting. The set bit flicker, click the “” or “” key to plus and minus the value, then press the “” key to complete setting.

Note : Generally the zero capacity voltage do not need to set. The default is 0V , mean invalid. If you want set , please understand the actual charge and discharge voltage of battery firstly.

★ Set capacity zero or full :

When on first use or change the battery , the memory capacity should be set zero or full: In the main interface ,hold the “” key for 3 seconds to set the capacity zero , the percentage is 0 ; hold the “” key for 3 seconds to set the capacity full , the percentage is 100. Attention that the operations can not be restored.

• Attention and warranty :

★ The tester cannot be exposed in the sun for a long time or in the environment with large amounts of ultraviolet radiation when using or storing ,particular in winter (< -20°C) and summer (>60°C) , otherwise it will shorten the life of LCD.

★ Within one year , any fault caused by non-artificial reason we should maintain it freely.

Our products will keep upgrading ,if the product you bought is different with this instruction , please take the material object or website as the standard.